

## ■ 繞綫型片式陶瓷體電感

### WIRE WOUND CHIP CERAMIC INDUCTORS



#### ● 特征 FEATURES:

- 體積小，適合高密度表面貼裝；
- 采用端電極結構，很好地抑制了引綫引起的寄生元件效應，具有高可靠性；
- 精度高、Q值高；
- 優良的焊接性和耐焊性。

- Miniature size, suitable for SMT;
- Using terminal electrode structure to restrain the parasitic component effect quite caused by lead;
- High Q value and Tight inductance tolerance;
- Excellent in solderability and heat resistance.

#### ● 應用 APPLICATIONS

- 移動通信、PDA;
- 各種高頻回路；
- 抑制各種高頻雜波。

- Portable communication equipment and PDA;
- High speed electronic device;
- Used for radiation high speed noise suppression.

#### ● 產品規格型號的表示方法 ORDERING CODE

$\frac{FHW}{①}$      $\frac{0805}{②}$      $\frac{UC}{③}$      $\frac{068}{④}$      $\frac{J}{⑤}$      $\frac{G}{⑥}$      $\frac{T}{⑦}$

①	②	③	④	⑤	⑥	⑦																																																				
產品代號 Code	規格尺寸 Dimensions (L × W) (mm)	材料 Material	感量(nH) Inductance	誤差 Tolerance	電極 Terminal	包裝方式 Packaging Style																																																				
FHW	<table border="1"> <tr><td>0402</td><td>1.0×0.5</td></tr> <tr><td>0603</td><td>1.6×0.8</td></tr> <tr><td>0805</td><td>2.0×1.2</td></tr> <tr><td>1008</td><td>2.5×2.0</td></tr> <tr><td>1210</td><td>3.2×2.5</td></tr> </table>	0402	1.0×0.5	0603	1.6×0.8	0805	2.0×1.2	1008	2.5×2.0	1210	3.2×2.5	<table border="1"> <tr><td>UC</td><td>陶瓷芯 Ceramic</td></tr> <tr><td>HC</td><td></td></tr> </table>	UC	陶瓷芯 Ceramic	HC		<table border="1"> <tr><td>1N0</td><td>1.0</td></tr> <tr><td>010</td><td>10</td></tr> <tr><td>R10</td><td>100</td></tr> <tr><td>1R0</td><td>1000</td></tr> <tr><td>100</td><td>10000</td></tr> </table>	1N0	1.0	010	10	R10	100	1R0	1000	100	10000	<table border="1"> <tr><td>B</td><td>±0.1nH</td></tr> <tr><td>C</td><td>±0.2nH</td></tr> <tr><td>S</td><td>±0.3nH</td></tr> <tr><td>D</td><td>±0.5nH</td></tr> <tr><td>F</td><td>±1%</td></tr> <tr><td>G</td><td>±2%</td></tr> <tr><td>H</td><td>±3%</td></tr> <tr><td>J</td><td>±5%</td></tr> <tr><td>K</td><td>±10%</td></tr> <tr><td>M</td><td>±20%</td></tr> </table>	B	±0.1nH	C	±0.2nH	S	±0.3nH	D	±0.5nH	F	±1%	G	±2%	H	±3%	J	±5%	K	±10%	M	±20%	<table border="1"> <tr><td>G</td><td>GOLD</td></tr> <tr><td>S</td><td>TIN</td></tr> </table>	G	GOLD	S	TIN	<table border="1"> <tr><td>T</td><td>卷帶盤裝 Tape&amp;Reel</td></tr> <tr><td>B</td><td>散裝Bulk</td></tr> </table>	T	卷帶盤裝 Tape&Reel	B	散裝Bulk
0402	1.0×0.5																																																									
0603	1.6×0.8																																																									
0805	2.0×1.2																																																									
1008	2.5×2.0																																																									
1210	3.2×2.5																																																									
UC	陶瓷芯 Ceramic																																																									
HC																																																										
1N0	1.0																																																									
010	10																																																									
R10	100																																																									
1R0	1000																																																									
100	10000																																																									
B	±0.1nH																																																									
C	±0.2nH																																																									
S	±0.3nH																																																									
D	±0.5nH																																																									
F	±1%																																																									
G	±2%																																																									
H	±3%																																																									
J	±5%																																																									
K	±10%																																																									
M	±20%																																																									
G	GOLD																																																									
S	TIN																																																									
T	卷帶盤裝 Tape&Reel																																																									
B	散裝Bulk																																																									

#### ● 外形尺寸 DIMENSIONS

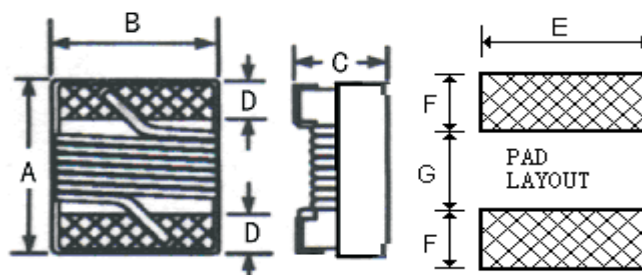

## 繞線型片式電感器

## WIRE WOUND CHIP INDUCTORS

單位(Unit): mm/inch

Par NO.	A (Max.)	B (Max.)	C (Max.)	D	E	F	G
0402	1.19 (.047)	0.66 (.026)	0.60 (.024)	0.23 (.009)	0.66 (.026)	0.36 (.014)	0.46 (.018)
0603	1.78 (.070)	1.10 (.043)	0.95 (.037)	0.30 (.012)	1.02 (.04)	0.64 (.025)	0.64 (.025)
0805	2.30 (.091)	1.70 (.067)	1.52 (.060)	0.50 (.020)	1.78 (.07)	1.02 (.04)	0.76 (.03)
1008	2.92 (.115)	2.79 (.110)	2.10 (.083)	0.5 (.020)	2.54 (.10)	1.02 (.04)	1.27 (.05)
1210	3.50 (.138)	2.90 (.114)	2.25 (.088)	0.50 (.020)	2.54 (.10)	1.02 (.04)	1.78 (.07)

### • 電性能參數 ELECTRICAL CHARACTERISTICS

#### 0402UC Series

PartNumber	Inductance ( nH)	Tolerance ( %)	Q ( min)	SRF(MHz) Min	Rdc( Ω ) Max	Idc( mA) Max
FHW0402UC1N0□GT	1.0@250MHZ	10	13@250MHZ	10000	0.045	1360
FHW0402UC2N2□GT	2.2@250MHZ	10,5	18@250MHZ	6000	0.070	960
FHW0402UC2N7□GT	2.7@250MHZ	10,5	15@250MHZ	6000	0.120	640
FHW0402UC3N3□GT	3.3@250MHZ	10,5	20@250MHZ	6000	0.066	840
FHW0402UC3N9□GT	3.9@250MHZ	10,5	20@250MHZ	6000	0.066	840
FHW0402UC4N7□GT	4.7@250MHZ	10,5,2	18@250MHZ	4500	0.200	640
FHW0402UC5N6□GT	5.6@250MHZ	10,5,2	20@250MHZ	4800	0.083	760
FHW0402UC6N8□GT	6.8@250MHZ	10,5,2	23@250MHZ	4800	0.260	680
FHW0402UC8N2□GT	8.2@250MHZ	10,5,2	25@250MHZ	4400	0.100	680
FHW0402UC010□GT	10@250MHZ	10,5,2	25@250MHZ	3900	0.200	480
FHW0402UC012□GT	12@250MHZ	10,5,2	25@250MHZ	3600	0.120	640
FHW0402UC015□GT	15@250MHZ	10,5,2	25@250MHZ	3280	0.300	560
FHW0402UC018□GT	18@250MHZ	10,5,2	25@250MHZ	3100	0.230	420
FHW0402UC022□GT	22@250MHZ	10,5,2	25@250MHZ	2800	0.300	400
FHW0402UC027□GT	27@250MHZ	10,5,2	24@250MHZ	2480	0.520	280
FHW0402UC033□GT	33@250MHZ	10,5,2	24@250MHZ	2350	0.650	350
FHW0402UC039□GT	39@250MHZ	10,5,2	25@250MHZ	2100	0.750	200
FHW0402UC047□GT	47@250MHZ	10,5,2	25@250MHZ	2100	0.83	150
FHW0402UC056□GT	56@250MHZ	10,5,2	25@250MHZ	1760	0.97	100
FHW0402UC068□GT	68@250MHZ	10,5,2	25@250MHZ	1620	1.12	100
FHW0402UC082□GT	82@250MHZ	10,5,2	25@250MHZ	1260	1.70	50
FHW0402UCR10□GT	100@250MHZ	10,5,2	25@250MHZ	1160	2.00	30
FHW0402UCR12□GT	120@250MHZ	10,5,2	25@250MHZ	1100	2.20	30

#### 0603UC Series

PartNumber	Inductance ( nH)	Tolerance ( %)	Q ( min)	SRF(MHz) Min	Rdc( Ω ) Max	Idc( mA) Max
FHW0603UC1N6□GT	1.6@250MHZ	10	18@250MHZ	12500	0.040	700
FHW0603UC1N8□GT	1.8@250MHZ	10	16@250MHZ	12500	0.045	700
FHW0603UC2N2□GT	2.2@250MHZ	10	12@250MHZ	10000	0.090	700
FHW0603UC3N3□GT	3.3@250MHZ	10	20@250MHZ	5900	0.075	700
FHW0603UC3N6□GT	3.6@250MHZ	10,5	22@250MHZ	5900	0.075	700
FHW0603UC3N9□GT	3.9@250MHZ	10,5	22@250MHZ	6900	0.080	700
FHW0603UC4N3□GT	4.3@250MHZ	10,5	22@250MHZ	5900	0.075	700
FHW0603UC4N7□GT	4.7@250MHZ	10,5	20@250MHZ	5800	0.116	700
FHW0603UC5N1□GT	5.1@250MHZ	10,5	20@250MHZ	5700	0.120	700
FHW0603UC5N6□GT	5.6@250MHZ	10	18@250MHZ	5700	0.200	700
FHW0603UC6N8□GT	6.8@250MHZ	10,5	27@250MHZ	5800	0.110	700
FHW0603UC7N5□GT	7.5@250MHZ	10,5	28@250MHZ	4800	0.110	700

PartNumber	Inductance ( nH)	Tolerance ( %)	Q ( min)	SRF(MHz) Min	Rdc( Ω ) Max	Idc( mA) Max
FHW0603UC8N2□GT	8.2@250MHZ	10,5	28@250MHZ	4700	0.120	700
FHW0603UC9N5□GT	9.5@250MHZ	10,5	26@250MHZ	5400	0.150	700
FHW0603UC010□GT	10@250MHZ	10,5,2	31@250MHZ	4800	0.130	700
FHW0603UC012□GT	12@250MHZ	10,5,2	35@250MHZ	4000	0.130	700
FHW0603UC015□GT	15@250MHZ	10,5,2	30@250MHZ	4000	0.150	700
FHW0603UC018□GT	18@250MHZ	10,5,2	35@250MHZ	3100	0.170	700
FHW0603UC022□GT	22@250MHZ	10,5,2	38@250MHZ	3000	0.190	700
FHW0603UC027□GT	27@250MHZ	10,5,2	36@250MHZ	2800	0.220	600
FHW0603UC033□GT	33@250MHZ	10,5,2	36@250MHZ	2300	0.220	600
FHW0603UC036□GT	36@250MHZ	10,5,2	36@250MHZ	2080	0.250	600
FHW0603UC039□GT	39@250MHZ	10,5,2	40@250MHZ	2200	0.250	600
FHW0603UC043□GT	43@250MHZ	10,5,2	36@250MHZ	2000	0.280	600
FHW0603UC047□GT	47@200MHz	10,5,2	36@200MHz	2000	0.280	600
FHW0603UC056□GT	56@200MHz	10,5,2	38@200MHz	1900	0.280	600
FHW0603UC068□GT	68@200MHz	10,5,2	36@200MHz	1700	0.340	600
FHW0603UC075□GT	75@150MHz	10,5,2	30@150MHz	1400	0.600	400
FHW0603UC082□GT	82@150MHz	10,5,2	34@150MHz	1700	0.550	400
FHW0603UCR10□GT	100@150MHz	10,5,2	30@150MHz	1400	0.630	400
FHW0603UCR12□GT	120@150MHz	10,5,2	32@150MHz	1300	0.730	300
FHW0603UCR15□GT	150@150MHz	10,5,2	28@150MHz	990	0.800	280
FHW0603UCR18□GT	180@100MHz	10,5,2	25@100MHz	990	1.450	240
FHW0603UCR20□GT	200@100MHz	10,5	25@100MHz	900	1.550	200
FHW0603UCR22□GT	220@100MHz	10,5	25@100MHz	900	2.100	200
FHW0603UCR27□GT	270@100MHz	10,5	24@100MHz	900	2.300	170
FHW0603UCR33□GT	330@100MHz	10,5	25@100MHz	900	3.890	100
FHW0603UCR39□GT	390@100MHz	10,5	25@100MHz	800	4.350	100

**0805UC Series**

PartNumber	Inductance ( nH)	Tolerance ( %)	Q ( min)	SRF(MHz) Min	Rdc( Ω ) Max	Idc( mA) Max
FHW0805UC2N2□GT	2.2@250MHz	10	50@1500MHz	8500	0.030	800
FHW0805UC2N7□GT	2.7@250MHz	10,5	50@1500MHz	8000	0.045	800
FHW0805UC3N3□GT	3.3@250MHz	10	35@1500MHz	7900	0.090	600
FHW0805UC4N7□GT	4.7@250MHz	10	40@1000MHz	6000	0.050	600
FHW0805UC5N6□GT	5.6@250MHz	10,5	50@1000MHz	5500	0.065	600
FHW0805UC6N8□GT	6.8@250MHz	10,5	50@1000MHz	5500	0.110	600
FHW0805UC8N2□GT	8.2@250MHz	10,5	35@1000MHz	4700	0.200	600
FHW0805UC010□GT	10@250MHz	10,5,2	50@500MHz	4200	0.150	600
FHW0805UC012□GT	12@250MHz	10,5,2	50@500MHz	4000	0.150	600
FHW0805UC015□GT	15@250MHz	10,5,2	45@500MHz	3400	0.170	600
FHW0805UC018□GT	18@250MHz	10,5,2	55@500MHz	3300	0.200	600
FHW0805UC022□GT	22@250MHz	10,5,2	55@500MHz	2600	0.220	500
FHW0805UC027□GT	27@250MHz	10,5,2	55@500MHz	2500	0.250	500
FHW0805UC033□GT	33@250MHz	10,5,2	55@500MHz	2050	0.270	500
FHW0805UC039□GT	39@250MHz	10,5,2	55@500MHz	2000	0.290	500
FHW0805UC047□GT	47@200MHz	10,5,2	55@500MHz	1650	0.310	500
FHW0805UC056□GT	56@200MHz	10,5,2	55@500MHz	1550	0.340	500
FHW0805UC068□GT	68@200MHz	10,5,2	55@500MHz	1450	0.380	500
FHW0805UC075□GT	75@200MHz	10,5,2	55@500MHz	1400	0.400	400
FHW0805UC082□GT	82@150MHz	10,5,2	55@500MHz	1300	0.420	400
FHW0805UCR10□GT	100@150MHz	10,5,2	50@500MHz	1200	0.460	400
FHW0805UCR12□GT	120@150MHz	10,5,2	45@250MHz	1100	0.510	400
FHW0805UCR15□GT	150@100MHz	10,5,2	45@250MHz	920	0.560	400
FHW0805UCR18□GT	180@100MHz	10,5,2	45@250MHz	870	0.640	400
FHW0805UCR22□GT	220@100MHz	10,5,2	40@250MHz	850	1.050	400
FHW0805UCR27□GT	270@100MHz	10,5,2	40@250MHz	650	1.100	350

## 繞線型片式電感器

## WIRE WOUND CHIP INDUCTORS

PartNumber	Inductance (nH)	Tolerance (%)	Q (min)	SRF(MHz) Min	Rdc(Ω) Max	Idc(mA) (Max)
FHW0805UCR33□GT	330@100MHz	10,5	40@250MHz	600	1.400	310
FHW0805UCR39□GT	390@100MHz	10,5	40@250MHz	560	1.500	290
FHW0805UCR47□GT	470@50MHz	10,5	33@100MHz	375	2.000	250
FHW0805UCR56□GT	560@25MHz	10,5	23@50MHz	340	1.900	230
FHW0805UCR68□GT	680@25MHz	10,5	23@50MHz	300	2.100	190
FHW0805UCR75□GT	750@25MHz	10,5	23@50MHz	280	2.120	180
FHW0805UCR82□GT	820@25MHz	10,5	23@50MHz	250	2.140	180
FHW0805UCR91□GT	910@25MHz	10,5	20@50MHz	220	2.280	180
FHW0805UC1R0□GT	1000@25MHz	10,5	20@50MHz	200	2.400	170
FHW0805UC1R2□GT	1200@7.9MHz	10,5	18@50MHz	180	2.550	170
FHW0805UC1R5□GT	1500@7.9MHz	10,5	18@50MHz	170	2.800	160
FHW0805UC1R8□GT	1800@7.9MHz	10,5	18@50MHz	140	3.800	150
FHW0805UC2R2□GT	2200@7.9MHz	10,5	16@7.9MHz	50	4.200	150

### 1008UC Series

PartNumber	Inductance (nH)	Tolerance (%)	Q (min)	SRF(MHz) Min	Rdc(Ω) Max	Idc(mA) Max
FHW1008UC3N9□GT	3.9@50MHz	10,5	50@1500MHz	6000	0.035	1000
FHW1008UC4N7□GT	4.7@50MHz	10,5	50@1500MHz	6000	0.045	1000
FHW1008UC5N6□GT	5.6@50MHz	10,5	30@1000MHz	6000	0.180	1000
FHW1008UC8N2□GT	8.2@50MHz	10,5	50@1000MHz	5000	0.050	1000
FHW1008UC010□GT	10@50MHz	10,5,2	50@500MHz	4100	0.080	1000
FHW1008UC012□GT	12@50MHz	10,5,2	50@500MHz	3300	0.090	1000
FHW1008UC015□GT	15@50MHz	10,5,2	45@500MHz	2500	0.150	1000
FHW1008UC018□GT	18@50MHz	10,5,2	50@350MHz	2500	0.110	1000
FHW1008UC022□GT	22@50MHz	10,5,2	55@350MHz	2400	0.120	1000
FHW1008UC027□GT	27@50MHz	10,5,2	55@350MHz	1600	0.130	1000
FHW1008UC033□GT	33@50MHz	10,5,2	60@350MHz	1600	0.140	1000
FHW1008UC039□GT	39@50MHz	10,5,2	60@350MHz	1500	0.150	1000
FHW1008UC047□GT	47@50MHz	10,5,2	65@350MHz	1500	0.160	1000
FHW1008UC056□GT	56@50MHz	10,5,2	65@350MHz	1100	0.180	1000
FHW1008UC068□GT	68@50MHz	10,5,2	65@350MHz	1000	0.200	1000
FHW1008UC082□GT	82@50MHz	10,5,2	60@350MHz	1000	0.220	1000
FHW1008UCR10□GT	100@25MHz	10,5,2	60@350MHz	1000	0.560	650
FHW1008UCR12□GT	120@25MHz	10,5,2	60@350MHz	950	0.630	650
FHW1008UCR15□GT	150@25MHz	10,5,2	45@100MHz	800	0.700	580
FHW1008UCR18□GT	180@25MHz	10,5,2	45@100MHz	640	0.770	620
FHW1008UCR22□GT	220@25MHz	10,5,2	45@100MHz	620	0.840	500
FHW1008UCR27□GT	270@25MHz	10,5,2	45@100MHz	600	0.910	500
FHW1008UCR33□GT	330@25MHz	10,5,2	45@100MHz	500	1.050	450
FHW1008UCR39□GT	390@25MHz	10,5,2	45@100MHz	480	1.120	470
FHW1008UCR47□GT	470@25MHz	10,5,2	45@100MHz	450	1.190	470
FHW1008UCR56□GT	560@25MHz	10,5,2	45@100MHz	415	1.330	400
FHW1008UCR68□GT	680@25MHz	10,5,2	45@100MHz	375	1.470	400
FHW1008UCR82□GT	820@25MHz	10,5	45@100MHz	250	1.610	400
FHW1008UC1R0□GT	1000@25MHz	10,5	35@50MHz	210	1.750	370
FHW1008UC1R2□GT	1200@7.9MHz	10,5	35@50MHz	200	2.000	310
FHW1008UC1R5□GT	1500@7.9MHz	10,5	28@50MHz	180	2.300	330
FHW1008UC1R8□GT	1800@7.9MHz	10,5	28@50MHz	160	2.600	300
FHW1008UC2R2□GT	2200@7.9MHz	10,5	20@50MHz	90	2.800	280
FHW1008UC2R7□GT	2700@7.9MHz	10,5	22@25MHz	80	3.200	290
FHW1008UC3R3□GT	3300@7.9MHz	10,5	22@25MHz	70	3.400	290
FHW1008UC3R9□GT	3900@7.9MHz	10,5	16@25MHz	60	3.600	260
FHW1008UC4R7□GT	4700@7.9MHz	10,5	18@25MHz	60	4.000	260
FHW1008UC5R6□GT	5600@7.9MHz	10,5	18@7.9MHz	55	7.600	240
FHW1008UC6R8□GT	6800@7.9MHz	10,5	18@7.9MHz	50	8.200	200
FHW1008UC8R2□GT	8200@7.9MHz	10,5	18@7.9MHz	40	8.200	170
FHW1008UC100□GT	10000@7.9MHz	10,5	20@7.9MHz	40	9.100	160

**1210HC Series**

PartNumber	Inductance (nH)	Tolerance (%)	Q ( min)	SRF(MHz) Min	Rdc( Ω ) Max	Idc( mA) Max
FHW1210HC3N9□GT	3.9@100MHz	10	30@300MHz	6000	0.050	1000
FHW1210HC4N7□GT	4.7@100MHz	10,5	30@300MHz	5800	0.065	1000
FHW1210HC8N2□GT	8.2@100MHz	10	30@300MHz	5500	0.070	1000
FHW1210HC010□GT	10@100MHz	10,5,2	40@300MHz	4000	0.080	1000
FHW1210HC012□GT	12@100MHz	10,5	40@300MHz	3200	0.080	1000
FHW1210HC015□GT	15@100MHz	10,5	40@300MHz	3200	0.100	1000
FHW1210HC018□GT	18@100MHz	10,5,2	50@300MHz	2800	0.100	1000
FHW1210HC022□GT	22@100MHz	10,5	50@300MHz	2000	0.100	1000
FHW1210HC027□GT	27@100MHz	10,5,2	50@300MHz	1800	0.110	1000
FHW1210HC033□GT	33@100MHz	10,5,2	55@300MHz	1800	0.110	1000
FHW1210HC039□GT	39@100MHz	10,5,2	55@300MHz	1800	0.120	1000
FHW1210HC047□GT	47@100MHz	10,5,2	55@300MHz	1500	0.130	1000
FHW1210HC056□GT	56@100MHz	10,5,2	55@300MHz	1450	0.140	1000
FHW1210HC068□GT	68@100MHz	10,5,2	55@300MHz	1200	0.150	900
FHW1210HC082□GT	82@100MHz	10,5,2	55@300MHz	1000	0.200	900
FHW1210HCR10□GT	100@100MHz	10,5,2	55@300MHz	900	0.210	850
FHW1210HCR12□GT	120@100MHz	10,5,2	60@300MHz	800	0.210	800
FHW1210HCR15□GT	150@100MHz	10,5,2	60@300MHz	780	0.250	750
FHW1210HCR18□GT	180@50MHz	10,5,2	60@300MHz	760	0.300	700
FHW1210HCR22□GT	220@50MHz	10,5,2	60@300MHz	650	0.320	670
FHW1210HCR27□GT	270@50MHz	10,5,2	55@300MHz	620	0.340	630
FHW1210HCR33□GT	330@50MHz	10,5,2	45@150MHz	600	0.380	590
FHW1210HCR39□GT	390@50MHz	10,5,2	45@150MHz	510	0.580	530
FHW1210HCR47□GT	470@50MHz	10,5,2	45@150MHz	500	0.800	490
FHW1210HCR56□GT	560@35MHz	10,5	45@150MHz	420	1.100	460
FHW1210HCR68□GT	680@35MHz	10,5,2	45@150MHz	400	1.200	430
FHW1210HCR75□GT	750@35MHz	10,5,2	45@150MHz	380	1.70	400
FHW1210HCR82□GT	820@35MHz	10,5,2	45@150MHz	370	1.820	400
FHW1210HC1R0□GT	1000@35MHz	10,5,2	45@150MHz	340	1.850	320
FHW1210HC1R2□GT	1200@35MHz	10,5	35@150MHz	220	1.870	300
FHW1210HC1R5□GT	1500@7.9MHz	10,5	30@50MHz	160	1.950	310
FHW1210HC1R8□GT	1800@7.9MHz	10,5	30@50MHz	160	2.250	310
FHW1210HC2R2□GT	2200@7.9MHz	10,5	30@50MHz	110	2.410	310
FHW1210HC2R7□GT	2700@7.9MHz	10,5	25@25MHz	100	2.850	300
FHW1210HC3R3□GT	3300@7.9MHz	10,5	20@25MHz	85	3.120	300
FHW1210HC3R9□GT	3900@7.9MHz	10,5	20@25MHz	80	3.600	290
FHW1210HC4R7□GT	4700@7.9MHz	10,5	16@25MHz	60	4.000	280
FHW1210HC5R6□GT	5600@7.9MHz	10,5	20@7.9MHz	60	5.000	250
FHW1210HC6R8□GT	6800@7.9MHz	10,5	20@7.9MHz	55	8.000	230
FHW1210HC8R2□GT	8200@7.9MHz	10,5	20@7.9MHz	50	8.600	170
FHW1210HC100□GT	10000@7.9MHz	10,5	22@7.9MHz	20	6.800	200

特性曲線  
CHARACTERISTIC CURVE

頻率特性  
FREQUENCY CHARACTERISTIC

Ls VS FREQ.

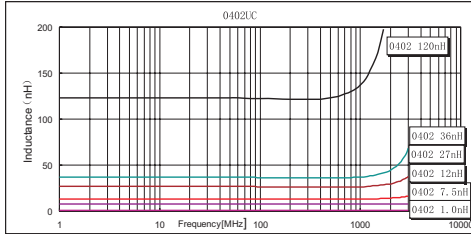

Q VS FREQ.

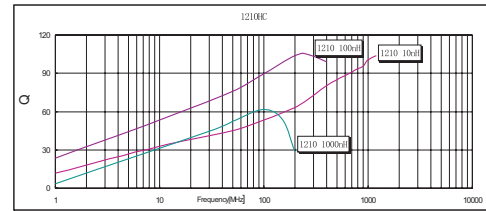
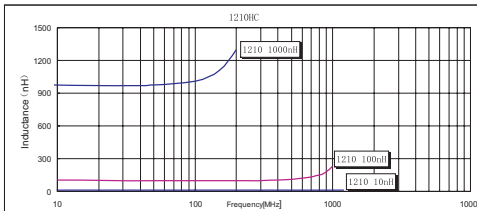
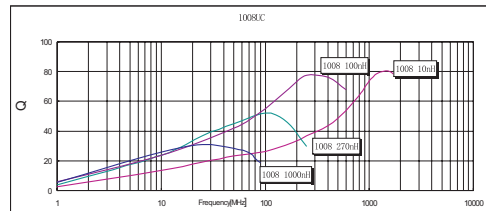
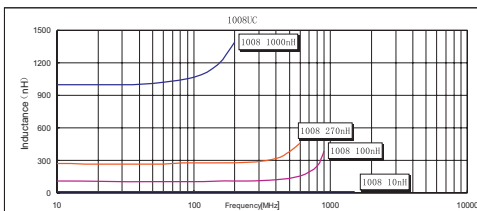
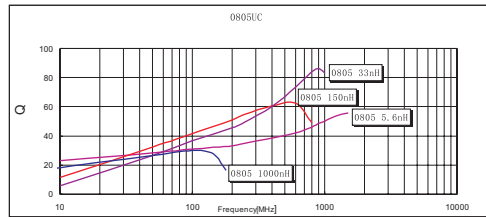
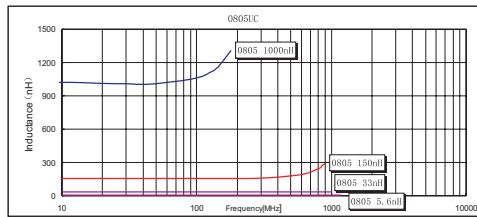
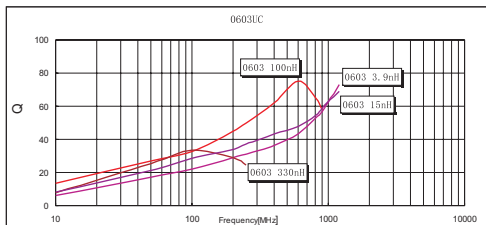
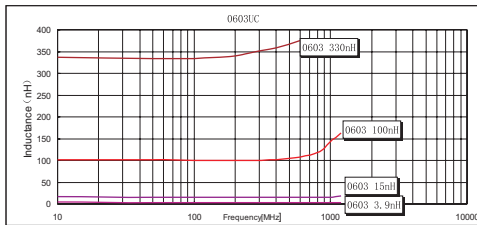
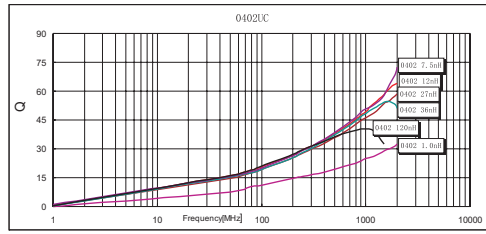

## ■ 電性能測試 Electrical Specification Test

序號 NO.	項目 Item	詳細說明Specified value	試驗方法Test methods
		0402UC、0603UC、0805UC、1008UC、1210HC	
1	工作溫度 Operating Temp. Range	-40°C~+125°C	
2	儲存溫度 Storage Temp. Range	-10°C~+40°C	
3	額定電流 Rated Current	150~1360mA(Max)	測試設備：CH102+1320 or HP4284A+HP42841A Test Equipment: CH102+1320 or HP4284A+HP42841A
4	電感量 Inductance	1.0~10000nH	測試頻率：7.9~250MHz Test Frequency : 7.9~250MHz 測試設備：HP4286A or HP4287A +16193A or 16197A Test Equipment: HP4286A or HP4287A+16193A or 16197A
5	品質因數 Q	13~65(min)	測試頻率：7.9~250MHz Test Frequency : 7.9~250MHz 測試設備：HP4286A or HP4287A +16193A or 16197A Test Equipment: HP4286A or HP4287A+16193A or 16197A
6	直流電阻 Rdc	0.03~9.1Ω(Max)	測試設備：HP4263B or HP4286A Test Equipment: HP4263B or HP4286A
7	自諧頻率 SRF	20~12500MHz(Min)	測試設備：HP8720D Test Equipment: HP8720D

■ 可靠性測試 Reliability Test

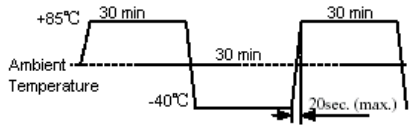
序號 NO.	項目 Item	詳細說明Specified value	試驗方法Test methods
		0402UC、0603UC、0805UC、1008UC、1210HC	
1	可焊性 Solderability	外觀不發生變化; There shall be no case deformation or change in appearance; 至少90%端電極表面被焊錫覆蓋。 At least 90% of terminal electrode is covered by new solder	焊接溫度: : 245±5°C Solder temp.: 245±5°C 浸入時間: 5±1秒 Duration:5±1S
2	耐焊性 Resistance to soldering	外觀不發生變化; There shall be no case deformation or change in appearance; 感量變化不超過±5%; Inductance shall not change more than ±5%; Q值變化不超過±10%。 Q shall not change more than±10%.	焊接溫度: : 260±5°C Solder temp.: 260±5°C 浸入時間: 10±1秒 Duration:10±1S
3	溫度循環 Thermal shock		溫度: -40°C, 60±2分鐘 +85°C, 60±2分鐘 emperature:-40°C for 60±2min +85°C for 60±2min 循環次數: 10 Number of cycles:10 
4	高溫 High Temperature storage		溫度: +85°C±2°C Temperature:+85°C±2°C 時間: 96±2小時 Time: 96±2h
5	低溫 Low Temperature storage	溫度: -55°C±2°C Temperature:-55°C±2°C 時間: 96±2小時 Time: 96±2h	
6	恒定濕熱 Damp heat (steady state)	外觀不發生變化; There shall be no case deformation or change in appearance; 感量變化不超過±5%; Inductance shall not change more than ±5%; Q值變化不超過±10%。 Q shall not change more than±10%.	濕度: 90~95% RH Humidity:90 to 95% RH 溫度: 50±2°C Temperature:50±2°C 測試時間: 100±2小時 Duration: 100±2h
7	振動 Vibration		頻率: 10~55~10Hz Frequency: 10 to 55 to 10Hz 振幅: 1.5mm Amplitude:1.5mm X、Y、Z方向的時間: 每方向1小時45分鐘 Directions:1 hours 45minutes each in X,Y,Z direction.

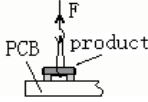
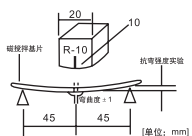

## ■ 可靠性測試 Reliability Test

序號 NO.	項目 Item	詳細說明Specified value	試驗方法Test methods
		0402UC、0603UC、0805UC、1008UC、1210HC	
8	端電極強度 Terminal Strength (Pull of Test)	0402UC: $\geq 0.45\text{Kg}$ ; 0603UC: $\geq 1.3\text{Kg}$ ; 0805UC、1008UC、1210HC: $\geq 2\text{Kg}$ .	
9	跌落 Drop	外觀不發生變化; There shall be no case deformation or change in appearance; 感量變化不超過 $\pm 5\%$ ; Inductance shall not change more than $\pm 5\%$ ; Q值變化不超過 $\pm 10\%$ 。 Q shall not change more than $\pm 10\%$ .	從高度為1米的空中自由落到混凝土地板重復10次。 Dropped 10 times on a concrete floor from a height of 1m.
10	抗彎強度 Flextrue strength	外觀不發生變化; There shall be no case deformation or change in appearance; 感量變化不超過 $\pm 5\%$ ; Inductance shall not change more than $\pm 5\%$ ; Q值變化不超過 $\pm 10\%$ 。 Q shall not change more than $\pm 10\%$ .	Flexure:20mm Test board:Glass -Epoxy board Thickness:0.8mm 
11	過載 Over Loading	外觀不發生變化; Appearance:No Damage ; 電感無開路。 Inductors shall not have a open winding.	施加2倍額定電流，電流誤差為 $\pm 2\%$ ，保持5分鐘。 Provide 2 times the rated current of direct current between inductor terminals, Direct current error 5%, and for 5 minutes.
12	壽命 Life	外觀不發生變化; There shall be no case deformation or change in appearance; 感量變化不超過 $\pm 5\%$ ; Inductance shall not change more than $\pm 5\%$ ; Q值變化不超過 $\pm 10\%$ 。 Q shall not change more than $\pm 10\%$ .	溫度: $85\pm 2^\circ\text{C}$ Temperature: $85\pm 2^\circ\text{C}$ 測試時間: 1000小時 Duration: 1000h 施加額定電流 Applied current: Rated current.

■ 包裝 Packaging Style

● 載帶 Tape

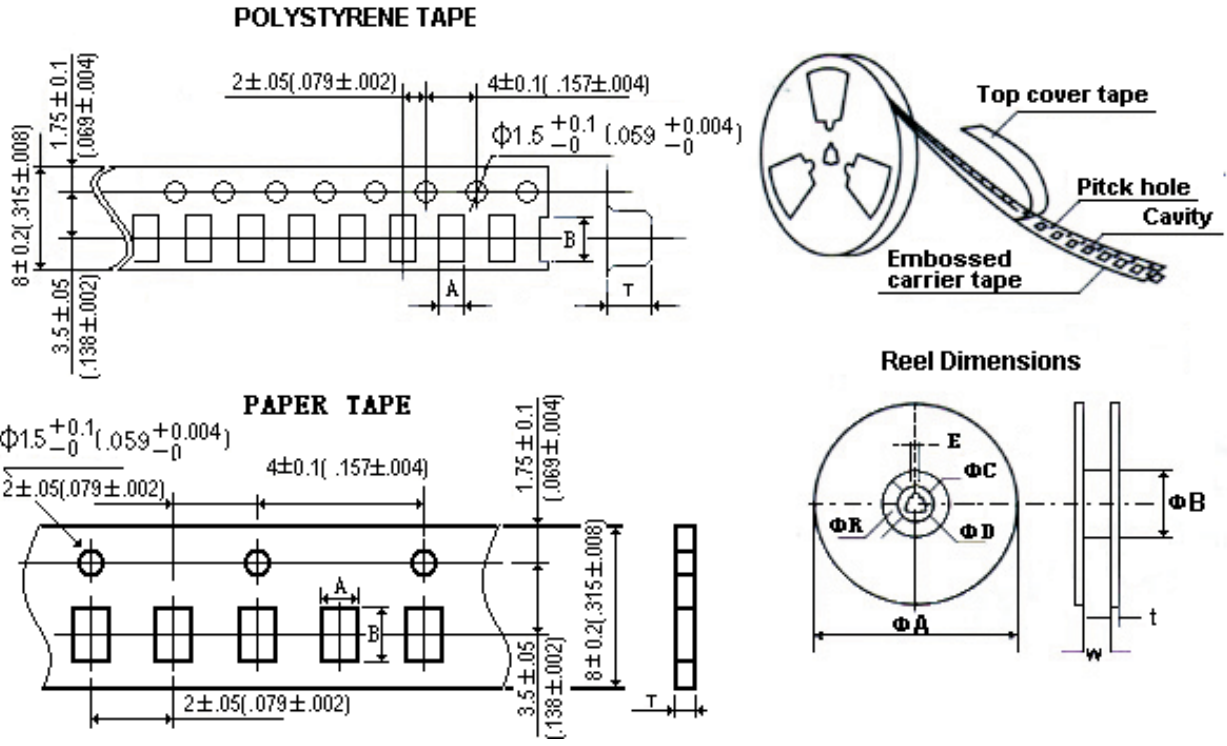

Unit(mm)

型號Type		A	B	T
紙帶 Paper Tape	0402	0.74	1.23	0.60
	0603	1.18	1.85	0.95
膠帶 Polystyrene tape	0805	1.85	2.45	1.50
	1008	2.73	2.90	2.34
	1210	2.96	3.60	2.40

Unit(mm)

型號 Type	ΦA	ΦB	ΦC	ΦD	E	W	t	R
0402 1210	178	60	13	21	2	10	2	1

● 剝離力Peeling off force

要求Pull strength  
0402~1210 : 20g ~80g

蓋帶剝離速度Speed of peeling off:  
300mm/min ± 10%

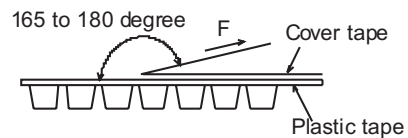

● 包裝數量  
Packaging Quantity

規格Dimension	0402	0603	0805	1008	1210
每卷數量Per Reel (pcs)	5000	4000	3000	2000	2000
每盒數量Per Box (pcs)	25000	20000	15000	10000	10000